

## 1.0 SCOPE

These instructions provide procedures for installing the V400 (Double Rod) Verabar flow sensor. Procedures are given for all industrial flow measurement applications including liquid, steam and gas service for both horizontal and vertical piping configurations.

## 2.0 RECEIVING INSPECTION

The following tasks should be performed as part of the receiving inspection procedure:

- Check items received against the packing list.
- Check sensor nameplate for proper model number, serial number and customer number.
- Verify that the actual pipe diameter matches the ID stated on the sensor nameplate.
- Check the bullet shaped sensor tube for any signs of damage. Damage to the sensor tube may result in erroneous flow readings.
- Check the round cover tube for any damage, especially axial gouges or scratches. Damage to the cover tube may prevent the packing from sealing properly.

## 3.0 SAFETY PRECAUTIONS

Prior to installation of the Verabar flow sensor, check maximum operating conditions on the flow sensor nameplate and verify that they exceed the maximum conditions of the installation. If any pressure, temperature or flow limits will be exceeded, consult the factory before proceeding.

## 4.0 INSTALLATION PREPARATIONS

### 4.1 Location

For the most accurate flow measurement, a minimum straight run of pipe is required. Table 1 shows the minimum straight run requirements. If longer straight runs are available, position the Verabar such that the ratio of upstream straight run to downstream straight run is approximately 4 to 1. If straight run lengths are less than the values stated in Table 1, consult the factory for additional accuracy and location information. For additional piping configurations, see Drawing SUB-4521.

Position straightening vanes such that the end closest to the Verabar is half way between the Verabar and the closest upstream configuration. For elbow installations, mount the Verabar in the same plane as the closest upstream elbow.

### 4.2 Orientation

Verify the proper sensor orientation by checking for an “H” (horizontal piping) or a “V” (vertical piping) in the model number on the Verabar name plate. Verify that the flow arrow stamped on the instrument head is pointing downstream in the direction of flow.

#### 4.2.1 Horizontal Piping

For air or gas installations, mount the Verabar in the upper 160° of the pipe to allow any condensate to drain into the pipe (Figure 1). For liquid or steam installations, mount the Verabar in the lower 160° of the pipe. This allows any entrained air to bleed back into the pipe for liquid applications and allows condensate to collect in the instrument piping for steam applications.

Piping Configuration	Dimension -A-		Dimension -B-	
	Without Straightening Vanes	With Straightening Vanes		
Elbow		7	7	3
Multiple Elbows in the Same Plane		9	9	3
Multiple Elbows in Different Planes		18	9	3
Reduction in Pipe Size		8	8	3
Increase in Pipe Size		8	8	3
Control Valve		24	9	4

Table 1. Straight Run Requirements

## 4.2.2 Vertical Piping

The Verabar may be mounted in any location around the circumference of the pipe for vertical piping applications (Figure 1).

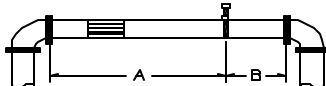
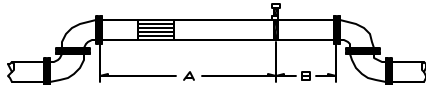
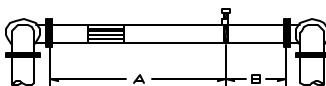
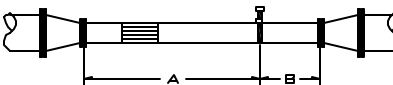
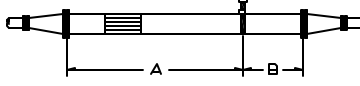
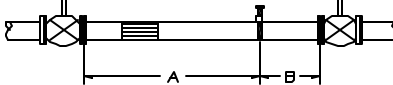
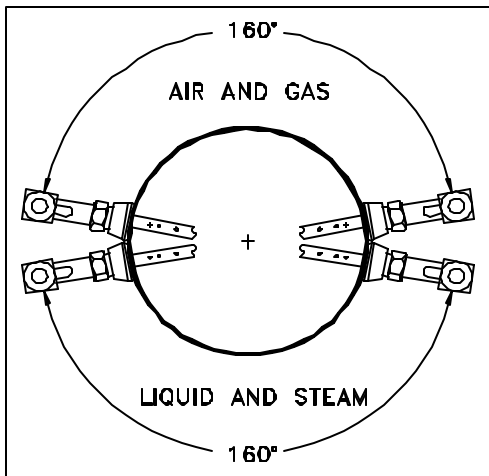

Figure 1. Verabar Orientation in Horizontal Pipe

## 4.3 DP Transmitter/Local Indicator Location

When choosing a Verabar location, consider the DP transmitter/local indicator location:

- The transmitter must be mounted below the Verabar for liquid and steam applications.
- The transmitter must be mounted above the Verabar for air and gas applications.

## 4.4 Installation Drawings and Bill of Materials

Additional information is available in the Installation Drawings and Bill of Materials VB-7061 (also on the VeraData CD). It contains standard and alternate transmitter locations and a complete bill of materials based on the fluid type and sensor orientation on the pipe.

## 4.5 Piping Support

For sensors that extend more than 36" (915mm) beyond the pipe wall or for sensors mounted in thin-walled pipes, external support of the Verabar is recommended. This will reduce stresses on the pipe wall.

## 5.0 INSTALLATION PROCEDURE

### 5.1 Assemble the Verabar

Your Verabar is shipped loosely assembled and is not properly tightened for proper pressure retention. Follow all assembly steps to ensure a safe installation (see Figure 2).

### 5.2 Install Instrument Valves or Manifold

#### 5.2.1 Valves

If the Verabar does not have a valve head, install instrument valves using proper thread sealant. Be sure instrument shut-off valves are installed and shut prior to repressurizing the pipe.

#### 5.2.2 Manifold

If the Verabar has a direct or integral manifold, be sure the high and low pressure block valves are shut off prior to repressurizing the pipe.

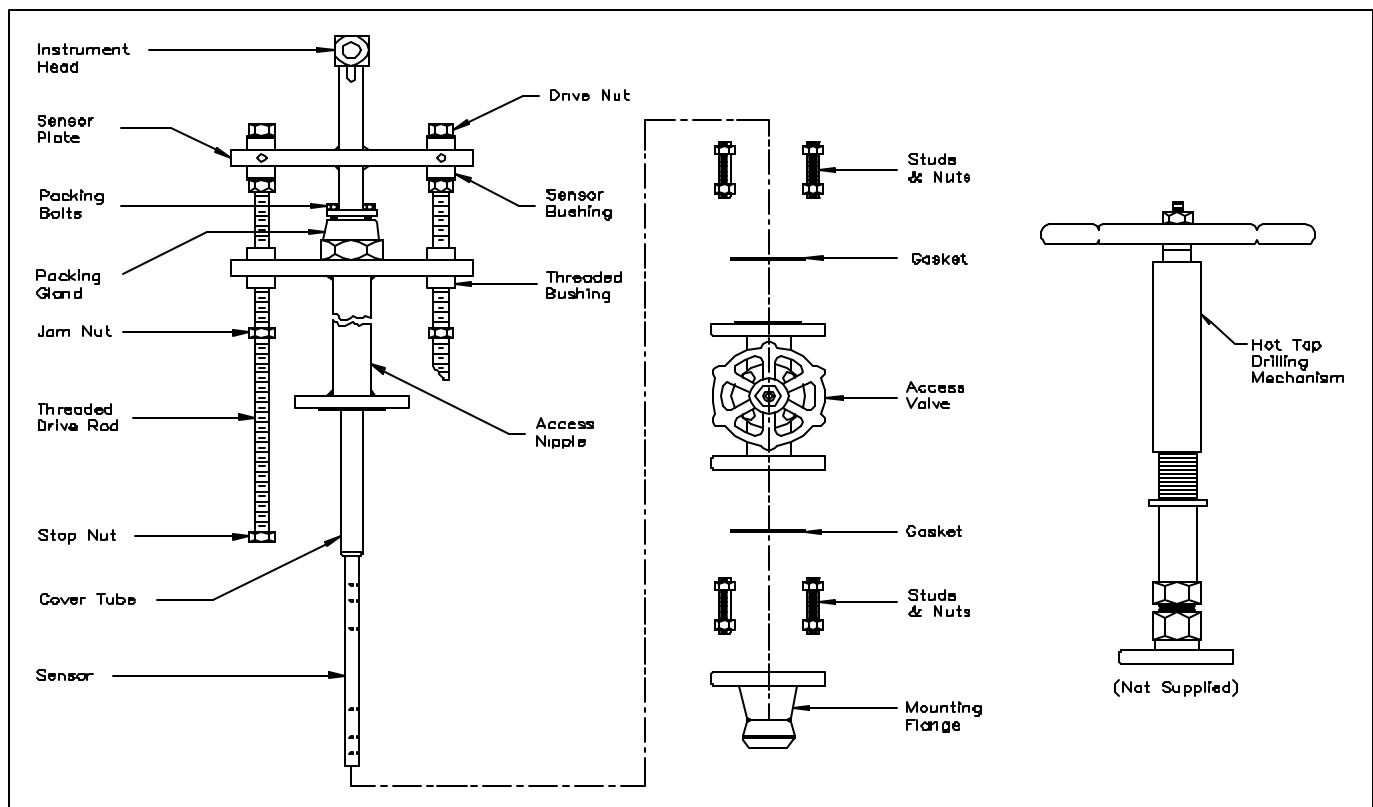

Figure 2. Verabar Model V400D (Double Rod)

### 5.3 Retract Sensor and Tighten Packing

Retract the Verabar such that the tip of the sensor is flush with the end of the access nipple (Figure 3). Tighten the packing bolts on the packing gland.

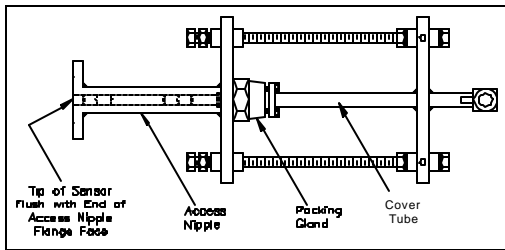

Figure 3. Access Nipple

### 5.4 Weld Mounting Flange to Pipe

Mark the location where the Verabar is to be mounted. Position the mounting flange over the center of the mark. Using the appropriate weld gap, tack weld the mounting flange into position. Note the flange orientation per Figure 4. The bolt holes on the flange should straddle the centerline of the pipe (2-holing pattern). Finish welding the mounting flange to the pipe per applicable codes.

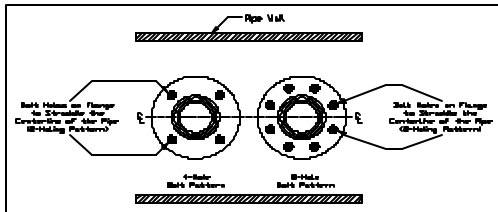

Figure 4. Flange Orientation

### 5.5 Install Access Valve

Bolt the access valve to the mounting flange using the gasket, studs and nuts provided.

#### 5.5.1 Horizontal Pipes

Orient the valve such that the valve stem is parallel with the centerline of the pipe (Figure 5).

#### 5.5.2 Vertical Pipes

Orient the valve such that the valve stem is perpendicular with the centerline of the pipe (Figure 5).

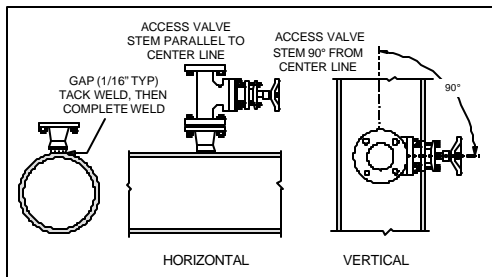

Figure 5. Access Valve

Verify that the access valve is properly tightened to the mounting flange, because beyond this point it will not be serviceable without depressurizing the line.

### 5.6 Drill Hole in Pipe

- With the access valve in the full open position, install an appropriate Hot Tap Drilling Machine (Figure 6) and drill a hole in the pipe (hole sizes

per the chart below). Follow the instructions given by the Hot Tap Drilling Machine.

Sensor Size	Hole Dia
V400-10	1" (25mm)
V400-15	1-1/2" (38mm)

- After the hole is completely drilled, retract the Hot Tap Drilling Machine. Shut off the access valve prior to removal of the Hot Tap Drilling Machine.

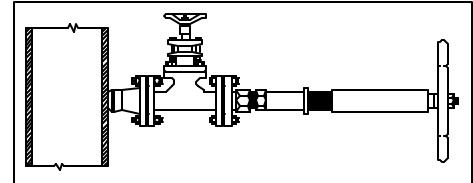

Figure 6. Hot Tap Drilling Machines

Note: There are numerous Hot Tap Drilling Machines on the market with various pressure and temperature ratings. These devices can usually be rented at a local utility company. For more information concerning Hot Tap Drilling Machines, the following companies can be contacted: Mueller Co., Decatur, IL (217) 423-4471 or T.D. Williamson Inc., Tulsa, OK (918) 446-1941.

### 5.7 Mount Sensor Assembly to Access Valve

Orient the sensor such that the arrow labeled "flow" on the instrument head is in the direction of the flow in the pipe to within 3° (orientation per Figure 7). Bolt the access nipple to the access valve using the gasket, studs and nuts provided.

### 5.8 Vent Access Valve to Verify No Leaks are Present

With the instrument valves shut, slowly crack open the access valve and verify that there are no process fluid leaks. If leaks are present, shut off the access valve and tighten the leaky joint.

### 5.9 Insert Verabar Sensor Assembly

**Warning: The flow rate must be decreased to the amount stated on the Verabar tag: the maximum insertion/withdrawn DP/flow limit.**

- The Verabar should be oriented such that the arrow on the head is pointing in the direction of flow.
- Completely open the access valve. Then, using the drive nut, insert the sensor. The drive nuts should be alternately tightened approximately 1/8" (3mm) at a time. This will prevent excess bowing of the cover tube and drive rods.
- The tip of the sensor should completely bottom on the opposite end of the pipe. Continue to insert the sensor until firm resistance is met. This will occur when the sensor plate is approximately 2" (51mm) from the top of the packing gland.
- Thread the jam nuts toward the threaded bushings. The jam nuts should press tightly against the threaded bushings. This will lock the drive rods in place and maintain the sensor position in the pipe.

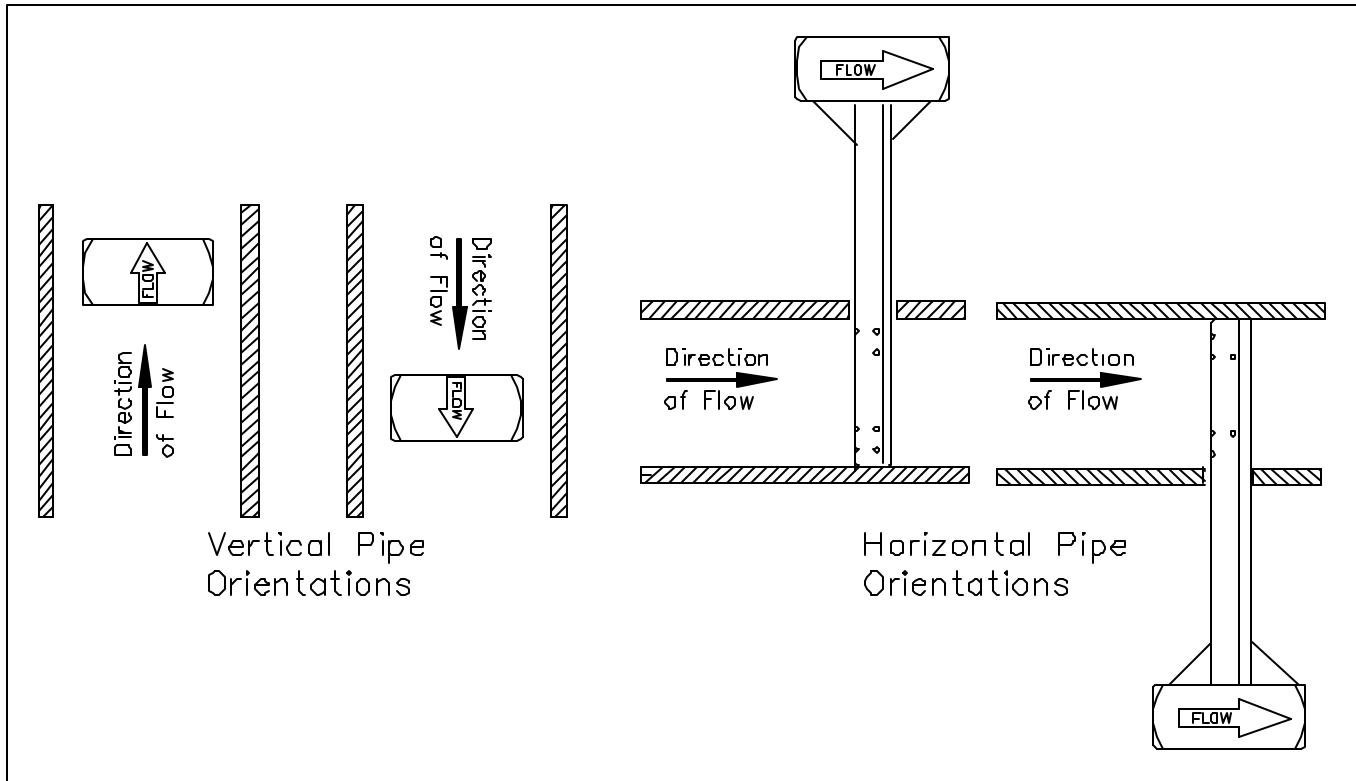

Figure 7. Orientation of Flow Arrow

The Verabar is now properly installed (Figure 8).

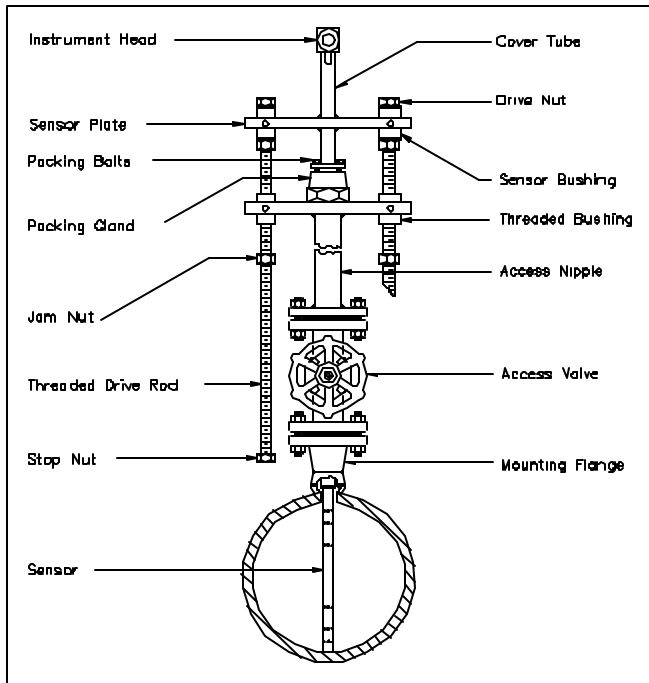

Figure 8. Installed V400 (Double)

### Periodic Maintenance

The assembly should be periodically checked. Verify that no leaks are present. The jam nuts and packing bolts should be tight.

### Sensor Removal Procedure

- Shut off instrument valves.
- Reduce flow rate to below the maximum insertion withdrawn DP/flow limit stated on the Verabar tag.
- Loosen jam nuts.
- Using the drive nuts, retract the sensor until the stop nuts and jam nuts are pressing against the threaded bushings. The drive nuts should be alternately loosened approximately 1/8" (3mm) at a time. This will prevent excess bowing of the cover tube and drive rods.
- Completely shut off the access valve. Slowly crack open one of the Verabar instrument valves and bleed off any remaining pressure contained in the access nipple. The sensor assembly can now be removed.